

Design Features

Alumilite designs reliable products produced with the best available materials, and we stand behind them with superior customer service. Please contact us for more information.

Shaft: The shaft shall be 4" diameter and extruded from seamless 6063 alloy aluminum. Poles can be side drilled or provided with a welded tenon for mounting luminaires. Available with smooth or fluted extrusion.

Anchor Base: The anchor base is cast from A356 alloy aluminum and shall be heat tempered to a T6 temper. The shaft and base are joined by a continuous circumferential weld at the outside top and inside bottom of the base.

Anchor Bolts: Each pole is supplied with four 3/4" by 15" long zinc-plated steel anchor bolts with two nuts, flat washers and template.

Finish: Standard finish is a baked on polyester powder. Color to be specified.

Packaging: Plastic sleeve shall cover each shaft prior to being inserted into a heavy gauge cardboard tube.

Caution: Poles should never be erected without luminaire installed. Grout must be installed between anchor base and concrete pad or the warranty will be voided.

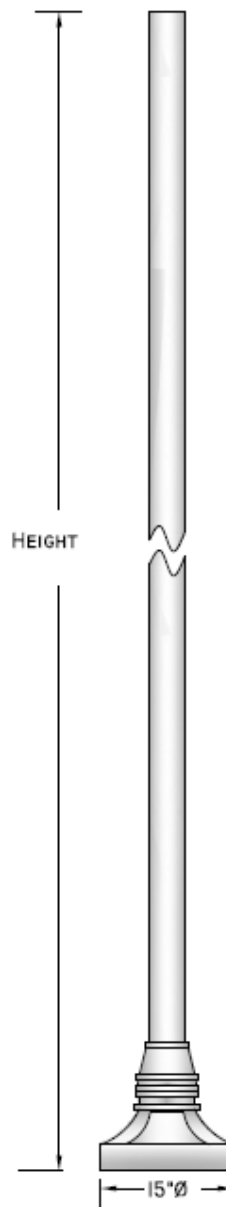
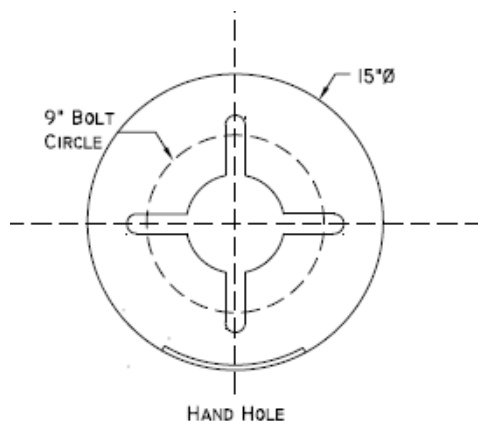

Base Design	Pole Height	Shaft	Options	Finish
DP7	10'	SM = Smooth	GFI = Ground Fault	BZ = Bronze
	12'	FL = Fluted	Receptacle	BK = Black
	14'			WH = White
				SL = Silver
				CC = Custom Color